

Pistol Grip Guns

Spoolmatic® and XR™-Pistol Guns

Issued August 2010 • Index No. M/1.73

MIG Guns for Aluminum Welding 

Quick Specs

Heavy Industrial Applications

Emergency Vehicles	Shipbuilding
Recreational Vehicles	Tool Boxes
Trucks and Trailers	Railcars
Boat/Yacht Building	Fabrication
Sign Manufacturers	

Processes

MIG (GMAW) Welding with aluminum wire and other soft alloys
Pulsed MIG (GMAW-P) with pulsing power source

Rated Output at 100% Duty Cycle

Spoolmatic 15A/30A: 200 A
XR-A Pistol: 200 A
XR-W Pistol: 400 A

Weight with Cable Assembly

Spoolmatic 15A: 9 lb (4.1 kg)
Spoolmatic 30A: 14 lb (6.4 kg)
XR-A Pistol (15 ft): 10.9 lb (4.9 kg)
XR-A Pistol (30 ft): 18.5 lb (8.4 kg)
XR-W Pistol (15 ft): 11.6 lb (5.3 kg)
XR-W Pistol (30 ft): 19.2 lb (8.7 kg)

The Power of Blue.®

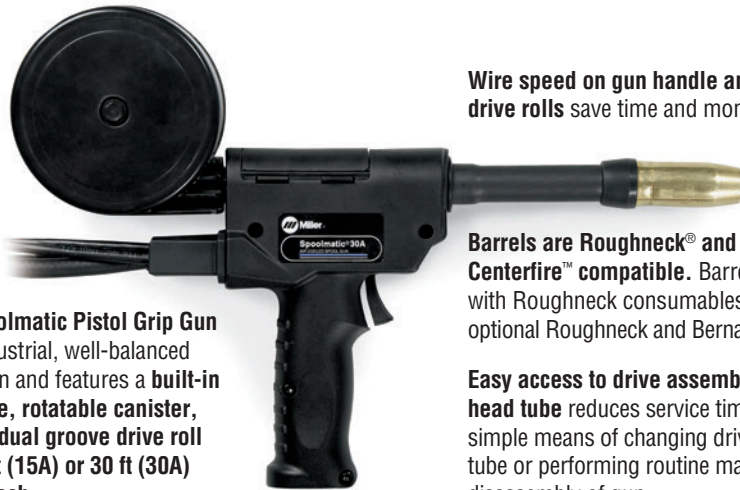

The Spoolmatic Pistol Grip Gun is an industrial, well-balanced spool gun and features a **built-in gas valve, rotatable canister, all-wire dual groove drive roll and 15 ft (15A) or 30 ft (30A) cable reach.**

Improved power block on Spoolmatic.

Wire speed on gun handle and reversible drive rolls save time and money.

Barrels are Roughneck® and Bernard® Centerfire™ compatible. Barrel comes standard with Roughneck consumables. (See page 5 for optional Roughneck and Bernard consumables.)

Easy access to drive assembly and removable head tube reduces service time by allowing a simple means of changing drive rolls and head tube or performing routine maintenance without disassembly of gun.

Quick-change, single-turn contact tip provides excellent performance and ease of replacement.



The XR-Pistol Grip Gun is available in air- or water-cooled versions with 15 or 30 ft (4.6 or 9 m) cable lengths. The replaceable feed cable liner saves time and money, while the trigger hold, when paired with the XR-S/D Control or XR-AlumaFeed, eliminates hand strain.

Also has new full leather cable cover with full length Velcro closure for easy maintenance.

Trigger hold reduces fatigue by allowing operator to weld without holding trigger. (Feature only available when XR-Pistol Grip Gun is paired with XR-S/D Control or XR-AlumaFeed.)

Replaceable feed cable liner reduces parts cost and service time by allowing a simple means of removing and replacing liner and not the complete feed cable. (XR-Pistol Grip Gun only.)



Guns are warranted for 1 year, parts and labor.

The Spoolmatic® Pistol Grip Gun

is designed to be used with the **WC-24, WC-115 Weld Control** or as a direct connect to select Millermatic power sources. (See pages 3 and 4 for a complete aluminum system.)

A Complete System Consists of the Following:

- **Spoolmatic Gun**
(Includes .035–1/16 in dual drive roll and two FasTip™ contact tips — .035 in and 3/64 in.)
- **WC-24 or WC-115 Weld Control**
(Required unless using a machine that allows direct hookup.)
- **Recommended Miller 14-pin power source OR select Milleramics** (See page 4.)



The XR™-Pistol Grip Gun is designed to be used with the **XR™-S/D Control** or **XR-AlumaFeed™** as part of a push-pull system.

A Complete System Consists of the Following:

- **XR-Pistol Grip Gun**
- **XR-S/D Control OR XR-AlumaFeed**
(See Lit. Index No. M/1.7 or DC/34.)
- **Recommended Miller 14-pin power source OR select Milleramics** (See page 3.)



Miller Electric Mfg. Co.
An Illinois Tool Works Company
1635 West Spencer Street
Appleton, WI 54914 USA

International Headquarters
Phone: 920-735-4505
USA FAX: 920-735-4134
Canadian FAX: 920-735-4169
International FAX: 920-735-4125

Web Site
www.MillerWelds.com



MADE IN **USA**
APPLETON, WI

Spoolmatic® Pistol Grip Gun Specifications (Subject to change without notice.)



Model	Welding Output Rating	Electrode Wire Diameter Capacity	Wire Speed	Maximum Spool Size Capacity	Dimensions	Net Weight with Cable Assembly
Spoolmatic 15A	200 A at 100% Duty Cycle	.030–1/16 in (0.8–1.6 mm) aluminum and hard wires up to .045 in (1.1 mm)	70–875 IPM (1.8–22.2 m/min)	4 in (102 mm)	H: 10-1/4 in (260 mm) W: 2-1/2 in (64 mm) L: 15-1/8 in (384 mm)	9 lb (4.1 kg)
Spoolmatic 30A						14 lb (6.4 kg)

Spoolmatic® Pistol Grip Gun Specifications (Air-Cooled Parts Breakdown and Gun Shown.)

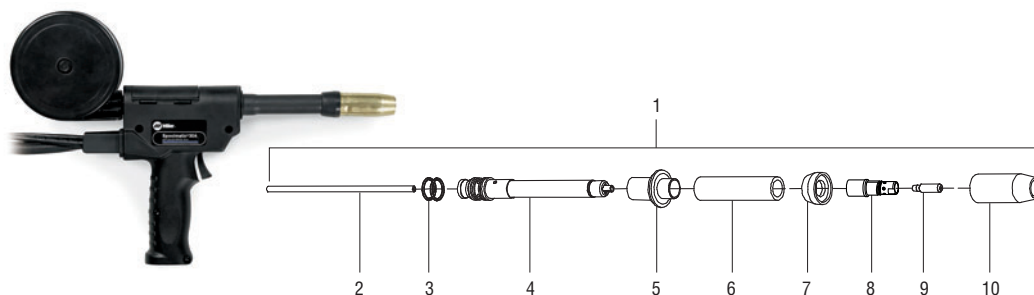

1. Air-Cooled Assembly **Kit #221 295**
2. Head Tube Liner **#212 156**
3. O-Ring .614 ID **#134 800**
4. Head Tube (Air-cooled) **#221 087**
5. Barrel Pistol Insulator **#219 795**
6. Outer Insulating Jacket **#219 794**
7. Nozzle Insulator **#232 284**
8. Diffuser **#227 749**
9. Contact Tip (See consumables)
10. Nozzle (See optional consumables)

Genuine Miller Spoolmatic® 30A Standard Consumables (Order from Miller Service Parts.)

Wire Size (Aluminum)	FasTip Contact Tip	Spoolmatic Drive Rolls	Spoolmatic All-Wire Dual Groove Drive Rolls	Head Tube Liner
.030 in (0.8 mm)	#206 186 .041 in ID	#183 357	#136 135	#212 156
.035 in (0.9 mm)	#206 187 .047 in ID	#183 357	#136 135	
.040 in (1.0 mm)	#206 188 .053 in ID	#183 357	#136 135	
3/64 in (1.2 mm)	#206 189 .061 in ID	#183 358	#136 135	
1/16 in (1.6 mm)	#206 190 .071 in ID	#183 358	#136 135	

Each gun is shipped with .035 in and .047 in standard tips.

Typical Installations

Note: Cords and cables are supplied unless noted otherwise on drawings below. Refer to Owner's Manual for complete installation instructions.

To connect the Spoolmatic 15A/30A and WC-24 control to older-style Miller or competitive CV power sources that **do not** have a 24 VAC supply, the PSA-2 control **#141 604** is required.

To connect Spoolmatic 15A/30A gun and WC-24 control to Millermatic® 200 power source that has a 4-pin receptacle, order adapter cord **#042 236**.

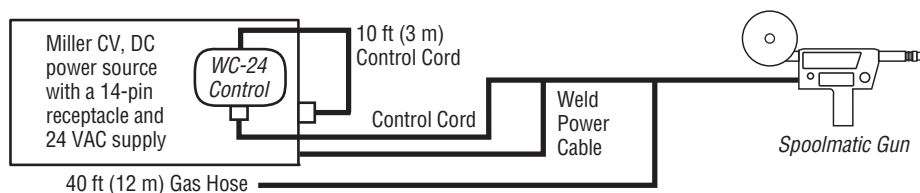

To connect the WC-115A control to older-style Miller power sources having Hubbell or 5-pin contactor control receptacles, the appropriate connector must be ordered **separately**:

To connect to older-style Miller CC power sources having a two-socket Hubbell connector, order plug **#039 618**.

If power source has a Miller 5-pin receptacle, order **#039 273 and #039 685**.

To connect to older-style Miller CV power sources having a two-prong Hubbell connector, order plug **#039 635**.

Note: These connectors are to replace the 14-pin connector on the 10 ft interconnect contactor cord. Internal wiring changes may be necessary.

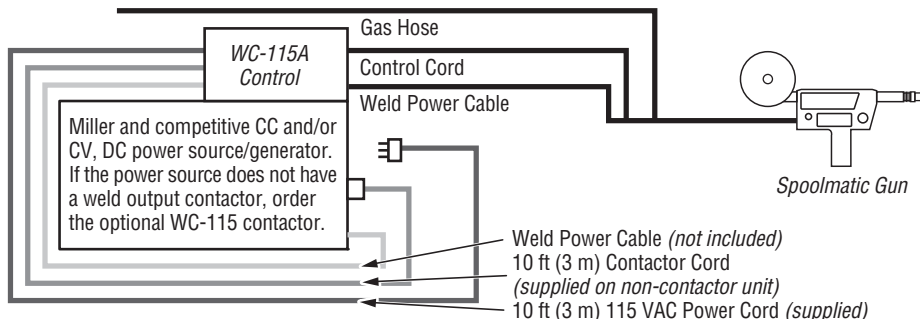

XR™-Pistol Grip Gun Specifications (Subject to change without notice.)



Model	Welding Output Rating	Electrode Wire Diameter Capacity	Wire Speed	Dimensions	Net Weight with Cable Assembly
XR-A Pistol	200 A at 100% Duty Cycle 250 A at 60% Duty Cycle	.030–1/16 in (0.8–1.6 mm) aluminum wire	70–875 IPM (1.8–22.2 m/min)	H: 7-3/8 in (187 mm) W: 1-7/8 in (48 mm) D: 10-5/8 in (270 mm)	15 ft Cable: 13 lb (5.9 kg) 30 ft Cable: 21 lb (9.5 kg)
XR-W Pistol	400 A at 100% Duty Cycle				15 ft Cable: 14 lb (6.4 kg) 30 ft Cable: 21.5 lb (9.8 kg)

A=Air-Cooled W=Water-Cooled Certified to both the Canadian and U.S. Standards for welding equipment.

XR™-Pistol Grip Gun (Air-Cooled Parts Breakdown and Gun Shown.)

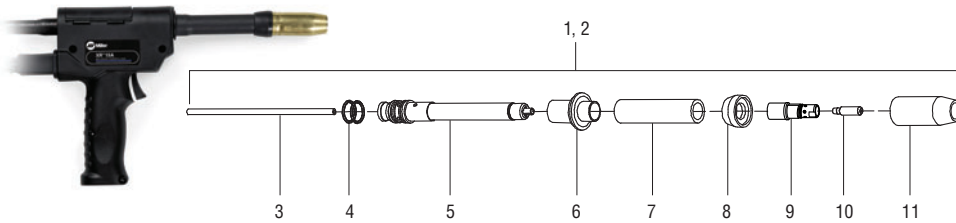

- | | |
|----------------------------|----------------------------|
| 1. Air-Cooled Assembly | Kit #231 523 |
| 2. Water-Cooled Assembly* | Kit #231 524 |
| 3. Head Tube Liner | #212 156 |
| 4. O-Ring .614 ID | #134 800 |
| 5. Head Tube (Air-cooled) | #221 087 |
| Head Tube (Water-cooled)* | #221 519 |
| 6. Barrel Pistol Insulator | #219 795 |
| 7. Outer Insulating Jacket | #219 794 |
| 8. Nozzle Insulator | #232 284 |
| 9. Diffuser | #227 749 |
| 10. Contact Tip | (See consumables) |
| 11. Nozzle | (See optional consumables) |
- *Order water-cooled parts from Miller Service Parts.

XR™-Pistol Grip Standard Consumables (Air-Cooled Only) (Order from Miller Service Parts.)

Wire Size (Aluminum)	FasTip Contact Tip	Drive Rolls	All-Wire Dual Groove Drive Rolls	Head Tube Liner	Cable Liners
.030 in (0.8 mm)	#206 186 .041 in ID	#183 357	#136 135	#212 156	#191 065 15 or 30 ft (4.6 or 9 m)
.035 in (0.9 mm)	#206 187 .047 in ID	#183 357	#136 135		
.040 in (1.0 mm)	#206 188 .053 in ID	#183 357	#136 135		
3/64 in (1.2 mm)	#206 189 .061 in ID	#183 358	#136 135		
1/16 in (1.6 mm)	#206 190 .071 in ID	#183 358	#136 135		

Note: These are replacement consumables. See back page for initial setup kits.

Typical Installations

Note: Cords and cables are supplied unless noted otherwise on drawings below. Refer to Owner's Manual for complete installation instructions.

XR-Pistol Grip Gun Hook-Up Recommendations

CV Power Supply	Control
Millermatic® 252, 350/350P	Direct Hook-Up
AlumaPower™ 350 MPa Deltaweld® Series Dimension™ Series Invision™ Series XMT® Series (except VS model) PipePro® 304 Trailblazer® 275 DC, 302, 302 Air Pak™	XR™-S/D Control or XR-AlumaFeed™

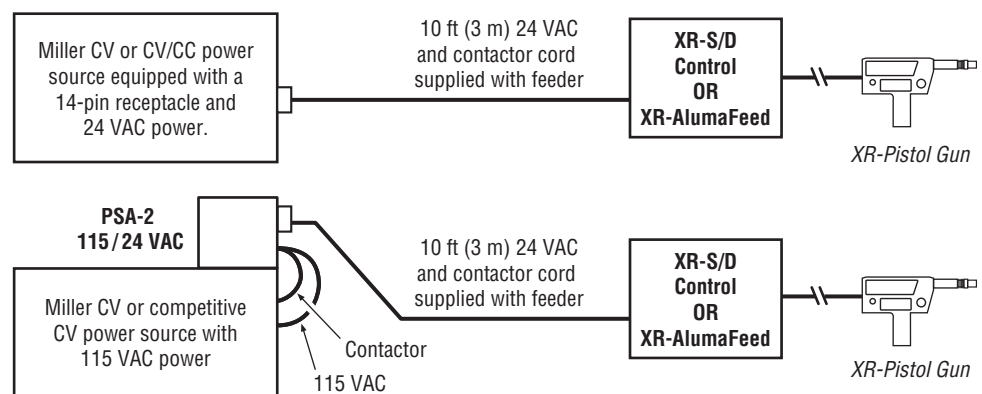

Spoolmatic® 15A/30A Spool Gun Controls

Spoolmatic 15A/30A Hook-Up Recommendations

CV Power Supply	Spoolmatic 15A/30A
Millermatic® Vintage*	Need Module #043 084
Millermatic® DVI™*, DVI ₂ ™*, 210*, 212*	Need Adapter Cable #195 287 (WFS controlled at machine)
Millermatic® 212 Auto-Set™, 250X*, 251*, 252, 300 w/meters*, 350/350P, Shopmate™ 300 DX	Direct Hook-Up
AlumaPower™ 350 MPa, CP Series, Deltaweld® Series, Dimension™ Series, Regency® 250*, Shopmaster™*, XMT® Series, PipePro® 304, Trailblazer® 275 DC, 302, 302 Air Pak™	Need WC-24 #137 549
Bobcat™ Series, Miller Legend® 302*	Need WC-115A #137 546-01-1

*Discontinued product.



WC-115A Weld Control

#137 546 Without contactor

#137 546-01-1 With contactor

This control operates on 115 VAC, and is designed primarily for CC DC power sources. It can also be used with CV power sources or DC engine drives supplying 115 VAC. When used with a CC source, the control circuit functions in a voltage-sensing mode.

When used with a CV source, it functions as a constant-speed circuit.

Standard features include a wire run-in control and a drive motor acceleration control which ensure optimum arc starting performance, regardless of the type of power source being used. The WC-115A comes with a 10 ft (3 m), wall-type plug power cord.

WC-115 Contactor Kit #137 548 Field Recommended when using the Spoolmatic gun and WC-115A control with power sources that do not have a weld output contactor. (This is installed in the WC-115A.)

Contactor Rating:

400 amps at 30% duty cycle
330 amps at 60% duty cycle
250 amps at 100% duty cycle



WC-24 Weld Control #137 549

Packaged in a compact, lightweight, non-metallic enclosure, the WC-24 easily mounts directly on the power source. It's designed for use with Miller CV power sources supplying 24 VAC and 14-pin receptacles. The control includes a board-mounted potentiometer which can alter the drive motor acceleration rate to optimize arc starting performance.

Spoolmatic® and XR™ Consumables—Roughneck® Series (Now Standard) (Order from Miller Service Parts.)

Nozzles

Screw-On Brass

- #199 610 1/2 in orifice, tapered
- #199 611 3/4 in orifice, straight
- #199 612 3/4 in orifice, straight HD
- #199 613 5/8 in orifice, tapered
- #199 614 5/8 in orifice, tapered HD

Screw-On Copper

- #199 615 1/2 in orifice, tapered
- #199 616 3/4 in orifice, straight
- #199 617 3/4 in orifice, straight HD
- #198 855 5/8 in orifice, tapered
- #199 618 5/8 in orifice, tapered HD
- #207 313 5/8 in orifice, tapered 15/16 OD
- #209 035 3/8 in orifice, tapered
- #209 036 1/2 in orifice, tapered

FasTip™ Contact Tips (25 per package)



Heavy-Duty (Aluminum Wire)

- #206 186 .030 in (0.8 mm)
- #206 187 .035 in (0.9 mm)
- #206 188 .040 in (1.0 mm)
- #206 189 3/64 in (1.2 mm)
- #206 191 1/16 in (1.6 mm)

Tapered (Aluminum Wire)

- #209 026 .030 in (0.8 mm)
- #209 027 .035 in (0.9 mm)
- #209 029 3/64 in (1.2 mm)
- #206 030 1/16 in (1.6 mm)

Gas Diffusers



- #227 749 Standard
1/8 in tip recess for heavy-duty FasTip™ contact tips.
- #231 511
1/4 in tip recess for heavy-duty FasTip™ contact tips.
- #231 512
Flush tip for heavy-duty FasTip™ contact tips.

Spoolmatic® and XR™ Consumables—Centerfire™ Series (Optional) (Order from Miller Service Parts.)

Aluminum Specific T Series Contact Tips

- T-035AL
- T-047AL
- T-062AL

T Series Contact Tips for Hard or Cored Wires 1.5 in (38.1 mm)

- T-030 .030 in (0.8 mm)
- T-035 .035 in (0.9 mm)
- T-039 .039 in (1.0 mm)
- T-045 .045 in (1.2 mm)
- T-052 .052 in (1.4 mm)
- T-062 1/16 in (1.6 mm)

TT Series Contact Tips for Hard or Cored Wires 2 in (50.8 mm)

- TT-030 .030 in (0.8 mm)
- TT-035 .035 in (0.9 mm)
- TT-045 .045 in (1.2 mm)
- TT-052 .052 in (1.4 mm)
- TT-062 1/16 in (1.6 mm)

Insulator **10012**
4323R

Diffuser **D-1**
DS-1

Nozzles

- N-3414C Copper, 3/4 in I.D., 1/4 in tip recess
- N-3418B Brass, 3/4 in I.D., 1/8 in tip recess
- N-3414B Brass, 3/4 in I.D., 1/4 in tip recess
- N-5814C Copper, 5/8 in I.D., 1/4 in tip recess
- N-5818B Brass, 5/8 in I.D., 1/8 in tip recess
- N-5814B Brass, 5/8 in I.D., 1/4 in tip recess
- NS-5818B Brass, 5/8 in I.D., 1/8 in tip recess
- NS-1218B Brass, 1/2 in I.D., 1/8 in tip recess
- NS-1200B Brass, 1/2 in I.D., flush tip
- NST-3818B Brass, 3/8 in I.D., 1/8 in tip recess

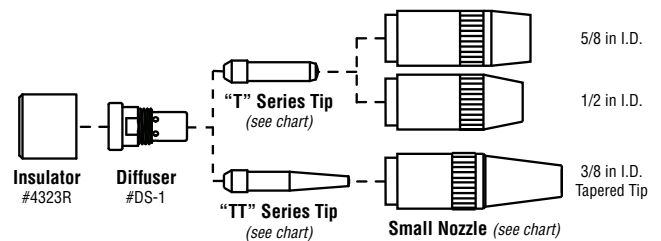
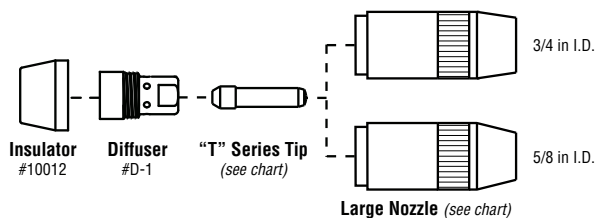

Spoolmatic® and XR™ Gun Genuine Miller Accessories

Hose and Cable Extension Kits

#132 228 25 ft (7.6 m)

#132 229 50 ft (15 m)

Extends Spoolmatic 30A away from the control box. Convenient plug-in connections. Includes gas hose, control cord, and weld power cable with International-style insulated connector. *For Spoolmatic only.*

Leather Cable Cover

#241 159 15 ft (4.6 m)

#241 160 30 ft (9 m)

Protects gun hose and cable assembly from wear and abrasion. Features full length Velcro closure for ease of maintenance or replacement. *For Spoolmatic or XR Guns.*

Hardwire Liner Kit for Steel and Stainless

#198 377 For 15 or 30 ft guns (4.6 or 9 m)

Kit consists of gun head tube liner and feed cable liner. Recommend using .030–.045 in mild steel, or stainless steel electrode wire. *For XR-Pistol Grip Gun only.*



1 lb (0.5 kg) Spool Canister #132 230

Ideal for use with XR guns if a small job arises requiring a different wire size and/or wire type that does not justify a 12 in (305 mm) spool of wire. The XR feed cable is removed if the spool canister is being used. (Canister accommodates 4 in [102 mm] spools of wire.)

Air-Cooled Gun Barrels

For Spoolmatic or XR Guns.



50 Degree Curved Barrel-A

#222 462 *For FasTip™ consumables*

6 in (152 mm). Used with .030–1/16 in (0.8–1.6 mm) wire. Kits supplied with liner that accommodates all wire sizes.



10 in Flex Head-A #222 735

For .030–1/16 in (0.8–1/6 mm) wire. Used in place of the standard straight barrel. Flexible head tube bends 60 degrees in any direction for easier joint access and improved operator comfort. Supplied with liners. Uses FasTip™ contact tips.



10 in Head Tube-A #222 461

Ideal when a longer reach is required.

Replacement Liners for Air-Cooled Barrels

(Order from Miller Service Parts.)

For 6 in 50 Degree Curved Barrel

#212 411 .030–1/16 in (0.8–1.6 mm) wire

For Flex Head

#222 853 .030–.035 in (0.8–0.9 mm) wire

#222 854 .047–.062 in (1.2–1.6 mm) wire

For 10 in Head Tube

#212 401 .030–1/16 in (0.8–1.6 mm) wire

50 Degree Curved Nozzle Kit-A

(Order from Miller Service Parts.)

#147 174 For old-style multi-piece barrels

#300 161 For newer Roughneck®-style barrels

Attaches to gun barrel assembly for access to confined weld joint areas. Used with .030–1/16 in (0.8–1.6 mm) wire. Kit includes two of each size contact tips to accommodate all wire sizes, Nozzle Adapter Kit and curved nozzle. Uses standard straight barrel head tube liner.

Replacement Contact Tips for Curved Nozzle

(Order from Miller Service Parts.)

#148 155 .030 and .035 in
(0.8 and 0.9 mm) wire

#148 154 .047 (1.2 mm) wire

#148 156 1/16 in (1.6 mm) wire

Water-Cooled Gun Barrels

For XR-Pistol Grip Gun only.



50 Degree Curved Barrel-W #222 464

6 in (152 mm). Used with .030–1/16 in (0.8–1.6 mm) wire. Kits supplied with liner that accommodates all wire sizes.

Replacement Liners for Water-Cooled Barrels

(Order from Miller Service Parts.)

For 6 in 50 Degree Curved Barrel

#212 411 .030–1/16 in (0.8–1.6 mm) wire

For 10 in Straight Barrel

#212 401 .030–1/16 in (0.8–1.6 mm) wire

Ordering Information

Important notes:

Spoolmatic Guns require a WC-24 or WC-115 Weld Control, unless used on a machine that allows direct hookup. Refer to chart on page 4.

XR-Pistol Grip Guns require XR-S/D Control or XR-AlumaFeed, or may be direct connected to a Millermatic 252 or 350/350P.

XR-Control must be serial #KK309906 or higher to be used with products and descriptions mentioned in this literature. To confirm a product's compatibility with older equipment, please contact the factory at 1-920-735-4505.

Equipment	Stock No.	Description	Qty.	Price
Spoolmatic® 15A Spool Gun	#195 156	Includes 15 ft (4.6 m) cable		
Spoolmatic® 30A Spool Gun	#130 831	Includes 30 ft (9 m) cable		
WC-24 Weld Control	#137 549	For Spoolmatic guns		
WC-115A Weld Control	#137 546 #137 546-01-1	Without contactor. For Spoolmatic guns With contactor. For Spoolmatic guns		
WC-115 Contactor Kit	#137 548	Field		
XR™-A Pistol Grip Gun (Air-Cooled)	#198 127 #198 128	15 ft (4.6 m) cable 30 ft (9 m) cable		
XR™-W Pistol Grip Gun (Water-Cooled)	#198 129 #198 130	15 ft (4.6 m) cable 30 ft (9 m) cable		
XR™-S Control (Includes .035 and 3/64 in drive rolls.)	#300 601	Standard model with wire feed speed digital display, jog/purge, run-in control, and trigger hold		
XR™-D Control (Includes .035 and 3/64 in drive rolls.)	#300 687	Enhanced model has same features as XR-S plus advanced digital and programming capabilities		
XR-AlumaFeed™ (Includes .035 and 3/64 in drive rolls.)	#300 509	Advanced model adds Profile Pulse™, synergic control, trigger schedule select, lock capabilities and flow meter		
XR-Control/AlumaFeed Drive Roll	#195 591	1/16 in (1.6 mm) (Order from Miller Service Parts.)		
Consumables and Accessories				
Consumables		See pages 2–5		
Hose and Cable Extension Kits	#132 228 #132 229	25 ft (7.6 m). Spoolmatic only 50 ft (15 m). Spoolmatic only		
Leather Cable Cover	#241 159 #241 160	15 ft (4.6 m) 30 ft (9 m)		
Spool Canister	#132 230			
Hardware Liner Kit for Steel and Stainless	#198 377	For 15 or 30 ft (4.6 or 9 m) XR Pistol Grip guns only		
Gun Barrels		See page 6		
Water Coolant Systems		See Lit. Index No. AY/7.2		

Date:

Total Quoted Price:



Distributed by: