

CP-302

Issued Nov. 2009 • Index No. DC/13

**MIG Welding
Power Source** 

Quick Specs

Industrial/Heavy Industrial Applications

Light Fabrication
Automotive
Furniture
Agricultural
Truck Body/Metal Fabrication
Small Equipment Manufacturing

Processes

MIG (GMAW)
Flux Cored (FCAW)

Input Power 3-Phase Power

Rated Output 300 A at 32 V, 100% Duty Cycle
390 A at 32 V, 60% Duty Cycle

Max. Open-Circuit Voltage 14-44

Weight 332 lb (151 kg)

The Power of Blue.®



See option and package descriptions on page 3.



Adjustable weld stabilizer (high-low inductance) provides the flexibility to produce the optimal arc characteristics. Use the high stabilizer setting for stainless steel and low setting for mild steel and aluminum.

Solid-state weld contactor provides longevity to match the ultra-durable and reliable reputation of the CP series.

115 VAC duplex receptacle provides 15 amps of auxiliary power.

14-pin receptacle provides quick, direct connection to wire feeders and accessories.

CP-302 MIGRunner® comes complete in one box. See page 3 for details.

Presettable welding voltage with voltmeter allows you to easily set weld output before welding.

Large analog volt and ammeters for easy viewing.

Power efficient which gives exceptional value and return on your investment.

Simple control panel with just one control adjustment.

Lower panel cover protects output connections from harsh welding environments.

CP-302 MIGRunner® Package shown

TRUE BLUE
3YR. WARRANTY

Welder is warranted for 3 years, parts and labor. Original main power rectified parts are warranted for 5 years.

MADE IN USA
APPLETON, WI 



Miller Electric Mfg. Co.
An Illinois Tool Works Company
1635 West Spencer Street
Appleton, WI 54914 USA

Equipment Sales US and Canada
Phone: 866-931-9730
FAX: 800-637-2315
International Phone: 920-735-4554
International FAX: 920-735-4125

Web Site
www.MillerWelds.com



Specifications (Subject to change without notice.)



Rated Output	Open-Circuit Voltage	Amps Input at Rated Output, Three-Phase, 60 Hz						Dimensions	Net Weight
		200 V	230 V	460 V	575 V	KVA	KW		
300 A at 32 V, 100% Duty Cycle	14-44	38	33	16.5	13.0	13.1	12.3	H: 30 in (762 mm) including lift eye W: 23 in (585 mm) D: 30-1/2 in (775 mm) including strain relief	332 lb (151 kg)
390 A at 32 V, 60% Duty Cycle		1.1*	.95*	.48*	.38*	.38*	.32*		

Conforms with NEMA EW 1, "Electric Arc Welding Power Sources", Class I (100).

*While idling.

Certified to both the Canadian and U.S. Standards for welding equipment.

Control Panel

1. Ammeter
2. Voltmeter
3. Power Switch
4. Pilot Light
5. Preset Indicator Light
6. Voltage Control

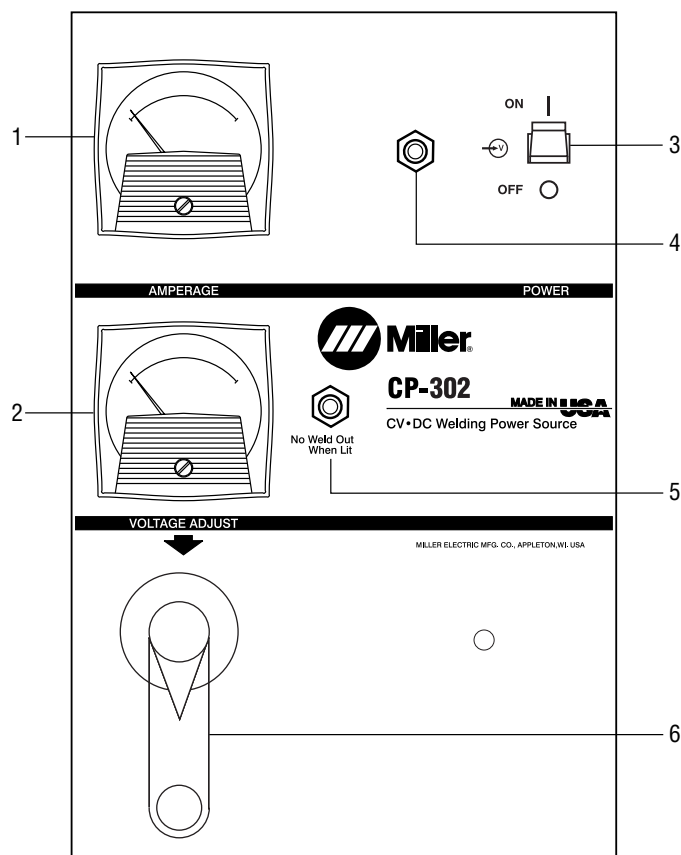

Performance Data

DUTY CYCLE CHART

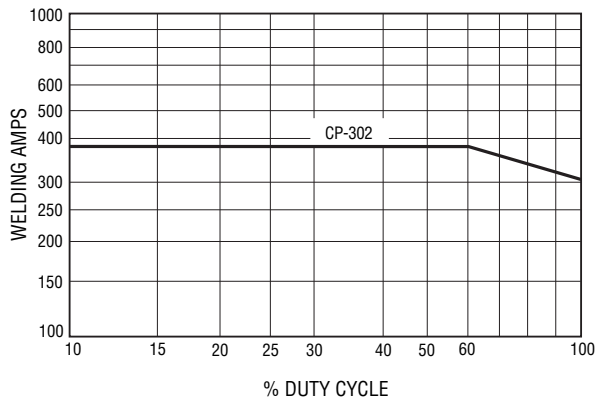

VOLT/AMP CURVE

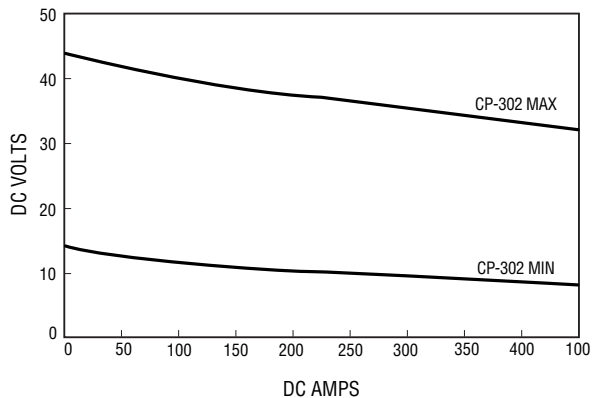



Option #1: CP-302 Power Sources

Purchase components separately.

CP-302

#903 786 (200/230/460 V, 60 Hz)

#903 521 (575 V, 60 Hz)



Option #2: CP-302 Stationary Package

Stationary display without running gear/cylinder rack.

CP-302 Stationary Package

#951 231 (200/230/460 V, 60 Hz)

Comes complete With:

- CP-302 power source
- 22A wire feeder
- Bernard® Q-Gun™
- Industrial MIG 4/0 Kit:
Smith® regulator/flowmeter with 10 ft (3 m) gas hose, 10 ft (3 m) 4/0 feeder weld cable with lugs, and 15 ft (4.6 m) work cable with 600-amp C-clamp



Option #3: CP-302 MIGRunner® Package

MIGRunner system with factory-installed running gear/cylinder rack.

CP-302 MIGRunner Package

#951 230 (200/230/460 V, 60 Hz)

Comes complete With:

- CP-302 power source
- 22A wire feeder
- Bernard® Q-Gun™
- Industrial MIG 4/0 Kit:
Smith® regulator/flowmeter with 10 ft (3 m) gas hose, 10 ft (3 m) 4/0 feeder weld cable with lugs, and 15 ft (4.6 m) work cable with 600-amp C-clamp
- Factory installed running gear/cylinder rack

Genuine Miller Accessories



Industrial MIG 4/0 Kit #300 390

Consists of Smith® regulator/flowmeter with 10 ft (3 m) gas hose, 10 ft (3 m) 4/0 feeder weld cable with lugs, and 15 ft (4.6 m) work cable with 600-amp C-clamp.



WC-24 Weld Control

#137 549

Packaged in a compact, lightweight, non-metallic enclosure, the WC-24 easily mounts directly on the power source. It's designed for use with Miller CV power sources supplying 24 VAC and 14-pin receptacles. The control includes a board-mounted potentiometer which can alter the drive motor acceleration rate to optimize arc starting performance.



Standard Running Gear #042 886

The large 10 in (254 mm) rear wheels and 5 in (127 mm) front casters on this running gear provide

excellent mobility on the shop floor, making it easier to move the power source. Very easy to install. Handles double as weld cable holder.

Standard Cylinder Rack #042 887

Holds two cylinders. Only installs on Standard Running Gear.

Wire Feeder Options

Bench-Style Feeders

S-22A	Lit. Index No.	M/11.0
S-24A		M/11.0
S-74S		M/3.0

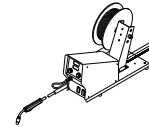

Bench-Style Dual Feeders

D-74S	M/3.0
-------	-------

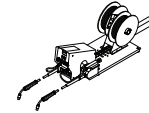

Boom-Style Feeders

SS-74S12	M/13.11
SS-74S16	M/13.11

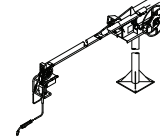

Boom-Style Dual Feeders

DS-74S12	M/13.11
DS-74S16	M/13.11

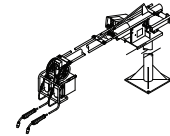

Spool Guns

Spoolmatic 15A	M/1.73
Spoolmatic 30A	M/1.73

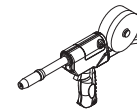

Ordering Information

Equipment and Options	Stock No.	Description	Qty.	Price
CP-302 Power Source Only	#903 786	200/230/460 V, 60 Hz		
	#903 521	575 V, 60 Hz		
CP-302 Stationary Package	#951 231	200/230/460 V, 60 Hz		
CP-302 MIGRunner Package	#951 230	200/230/460 V, 60 Hz		
Wire Feeders				
22A	#951 190	See Lit. Index No. M/11.0		
24A	#951 193	See Lit. Index No. M/11.0		
70 Series	#951 196	S-74S. See Lit. Index No. M/3.0		
	#951 203	D-74S. See Lit. Index No. M/3.0		
Swingarc™ Boom Feeders		See Lit. Index No. M/13.11		
Extension Cables for 14-Pin Plugs to 14-Pin Sockets	#122 973	25 ft (7.6 m)		
	#122 974	50 ft (15.2 m)		
	#122 975	75 ft (22.8 m)		
Spoolmatic® 15A	#195 156	See Lit. Index No. M/1.73		
Spoolmatic® 30A	#130 831	See Lit. Index No. M/1.73		
WC-24 Weld Control	#137 549			
Guns				
Bernard® Gun				
Consumables				
Accessories				
Industrial MIG 4/0 Kit	#300 390	Includes Smith regulator/flowmeter with 10 ft (3 m) gas hose, 10 ft (3 m) 4/0 feeder weld cable with lugs, and 15 ft (4.6 m) work cable with 600-amp C-clamp		
Standard Running Gear	#042 886			
Standard Cylinder Rack	#042 887			

Date:

Total Quoted Price:

Distributed by:

